

DIFFERENTIAL PRESSURE SWITCH

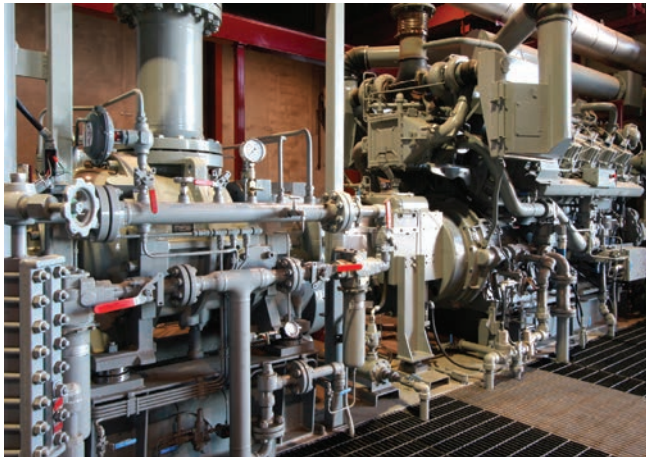

FEATURES

- Sealed Metal Bellows Sensors
- Welded 316 Stainless Steel Sensors
- Gasketed Die-Cast Aluminum Enclosure with Epoxy Coating
- Single Switch Output
- Adjustable Ranges:
30 "Hg Vac to 90 psid (-1 to 6 bar)

OVERVIEW

The J21K differential pressure switch monitors the difference between two system pressures or vacuums and senses excessive flow deviation, or verifies that a filter is clogged.

The J21K's rugged design - with epoxy coated enclosure and sealed metal bellows - lends itself to exacting applications. Widely used in refrigeration (chiller) and compressor applications, the J21K can be used for filter status monitoring and proof of flow.

FEATURES

- Designed to meet Enclosure Type 4X (with watertight conduit fitting)
- UL listed and cUL certified
- Optional ATEX and Rostechnadzor (GOST-R) intrinsic safety compliance
- Optional adjustable deadband
- Single switch output
- Opposing bellows design



J21K-150 differential pressure switch with nickel-plated brass pressure connections and brass bellows



J21K-254 differential pressure switch with brass pressure connections and phosphor bronze bellows

SPECIFICATIONS**AMBIENT TEMPERATURE LIMITS**

-40 to 160°F (-40 to 71°C); Set point typically shifts less than 1% of range for a 50°F (28°C) ambient temperature change

SET POINT REPEATABILITY

±1% of full scale range

SHOCK

Set point repeats after 15 G, 10 millisecond duration

VIBRATION

Set point repeats after 2.5 G, 5-500 Hz

ENCLOSURE

Die cast aluminum, epoxy powder coated, gasketed

ENCLOSURE CLASSIFICATION

Designed to meet enclosure type 4X requirements with M900 option (watertight conduit fitting)

SWITCH OUTPUT

One SPDT snap action switch; switch may be wired "normally open" or "normally closed"

ELECTRICAL RATING

15 A 125/250/480 VAC resistive. Electrical switches have limited DC capabilities. Consult factory for additional information.

WEIGHT

Approximately 2 lbs. (0.90 kg.)

ELECTRICAL CONNECTION

7/8" diameter conduit hole

PRESSURE CONNECTION

Models 127-150, 232-254, 357, 16020: 1/4" NPT (female); models S127B-S150B, 16021: 1/2" NPT (female)



APPROVALS



UNITED STATES AND CANADA

UL listed, **cUL** certified
UL 508; CSA C22.2, no. 14 File # E42272

Canadian Registration Number (CRN): Refer to www.ueonline.com/certifications for list of approved models



EUROPE

Low Voltage Directive (LVD) 73/23/EC & 93/68/EEC

Compliant to LVD
Products rated lower than 50 VAC and 75 VDC are outside the scope of the LVD

Pressure Equipment Directive (PED) 97/23/EC

Compliant to PED
Products rated lower than 7.5 psi are outside the scope of the PED



ATEX Directive (94/9/EC)

II 1G Ex ia IIC T6 Ga (**Optional - code M405**)
-50°C ≤ Tamb ≤ +60°C
UL International DEMKO A/S (N.B.#0539)
Certificate # DEMKO II ATEX 1105261X
EN 60079-0, 60079-11, 60079-26



RUSSIA

Rostekhnadzor Permit and GOST-R CoC (**Optional - code M406**)
0ExialICT6
Tamb = -50C to +60C
NANIO CCVE Certification Center
Certificate # ROSS US.GB05.Bo2933
GOST R 51330.0, 51330.1, 51330.10 & 51330.14

MODEL CHART

Model	Adjustable Set Point Range		Deadband		Differential Proof Pressure**		Working Pressure*	
	Low end of range on fall; psid (unless noted)	High end of range on rise bar (unless noted)	psi (unless noted)	bar (unless noted)	psid	bar	psi (unless noted)	bar
Welded 316L stainless steel bellows with 1/2" NPT (female) pressure connections								
S127B	30 "Hg Vac to 0	-1 to 0	0.4 to 0.6 "Hg	13,5 to 20,3 mbar	15	1.0	30 "Hg Vac to 0	-1 to 0
S140B	0 to 6	0 to 0,4	0.1 to 0.4	6,9 to 27,6 mbar	6	0,4	30 "Hg Vac to 30	-1 to 2,1
S150B	0 to 40	0 to 2,8	0.3 to 0.7	20,7 to 48,3 mbar	300	20,7	30 "Hg Vac to 300	-1 to 20,7
16021	1 to 15	0,07 to 1,0	0.1 to 0.6	6,9 to 41,4 mbar	125	8,6	30 "Hg Vac to 125	-1 to 8,6
316L welded stainless steel bellows with 1/4" NPT (female) pressure connections								
357	0 to 70	0 to 4,8	2 to 4	0,1 to 0,3	70	4,8	30 "Hg Vac to 350	-1 to 24,1
Brass bellows with 1/4" NPT (female) pressure connections								
127	30 "Hg Vac to 0	-1 to 0	0.4 to 0.6 "Hg	13,5 to 20,3 mbar	15	1.0	30 "Hg Vac to 0	-1 to 0
140	0 to 6	0 to 0,4	0.1 to 0.4	6,9 to 27,6 mbar	6	0,4	30 "Hg Vac to 30	-1 to 2,1
150	0 to 40	0 to 2,8	0.3 to 0.7	20,7 to 48,3 mbar	40	2,8	30 "Hg Vac to 180	-1 to 12,4
16020	1 to 15	0,07 to 1,0	0.1 to 0.6	6,9 to 41,4 mbar	125	8,6	30 "Hg Vac to 125	-1 to 8,6
Phosphor bronze bellows with 1/4" NPT (female) pressure connections								
232	0 to 25	0 to 1,7	0.6 to 1	41,4 to 68,9 mbar	25	1,7	30 "Hg Vac to 110	-1 to 7,6
254	0 to 90	0 to 6,2	2 to 4	0,1 to 0,3	90	6,2	30 "Hg Vac to 200	-1 to 13,8

***Working Pressure Range:** The pressure range within which two opposing sensors can be safely operated and still maintain set point adjustability.

**** Differential Proof Range:** The maximum differential pressure to which a pressure sensor may be occasionally subjected, which causes no permanent damage.

The unit may require calibration (e.g. start up, testing)



HOW TO ORDER

BUILDING A PART NUMBER

Select a **Type**

Refer to the "Type" section below

Determine type number based on switch output, enclosure, adjustment and reference.

Fill in the type portion of your part number with the corresponding number.

Select a **Model**

Refer to the "Model Charts"

Determine model based on adjustable range, deadband and proof pressure.

Fill in the model portion of your part number with the corresponding number.

Select an **Option**

Refer to the "Options" section

Determine option number based on switch output, optional materials or other product enhancements.

Fill in the option portion of your part number with the corresponding number. Leave "option" portion blank if no options are needed.

FOR MULTIPLE OPTIONS: Call United Electric Controls.

TYPE	DESCRIPTION
Differential Pressure	Type J21K - one SPDT output, internal adjustment with no reference dial.

SWITCH OPTIONS*

0140	Gold contacts, 1 A 125 VAC resistive
0500	Close deadband, 5 A 125/250 VAC resistive
1520	Adjustable deadband, 15 A 125/250/277 VAC resistive; adjustment wheel changes rise setting only. If adjustment on fall setting is required use primary adjustment
1535	High ambient, 15 A 125/250 VAC resistive; temperatures up to 250°F (121°C)
1537	Vapor sealed switch, 15A 125/250 VAC resistive

OTHER OPTIONS

M201	Factory set one switch; specify increasing or decreasing pressure and set point
M277	Range indicated on nameplate in kPa or MPa, factory selected
M278	Range indicated on nameplate in Kg/cm ²
M405	European ATEX Intrinsic Safety compliance
M406	Intrinsic safety compliance per Russian Rostekhnadzor (GOST-R)
M444	Paper ID tag
M446	Stainless steel ID tag & wire attachment
M550	Oxygen service cleaning; alcohol cleaning to remove residue from the process connection. NOT AVAILABLE MODEL 254
M900	Watertight conduit fitting; converts 7/8" hole to 1/2" NPT fitting. Required for product to meet Enclosure Type 4X

*All switches have limited DC capabilities. Consult factory for details.

DIMENSIONAL DRAWINGS

Dimensional drawings for all models may be found at www.ueonline.com

Type J21K

INTERNAL SET POINT ADJUSTMENT

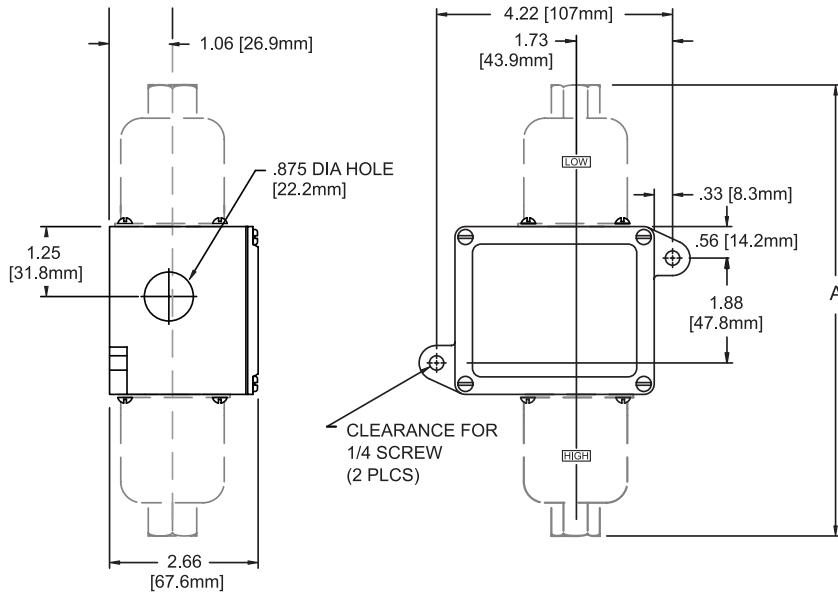

Models	Dimension A		
	Inches	mm	NPT
127-16020	8.06	204.7	1/4
S127B-16021	8.86	225.0	1/2
232	6.53	165.9	1/4
254	6.50	165.1	1/4
357	6.88	174.8	1/4

All dimensions stated in inches (millimeters)

PRESSURE SENSORS

Model 127-16020

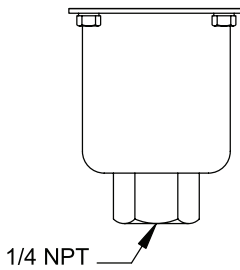

Model S127B-16021

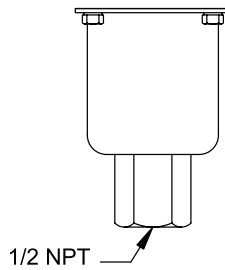

Model 232

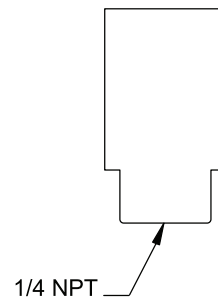

Model 254

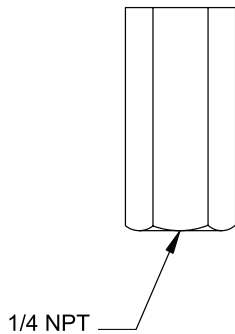

Model 357

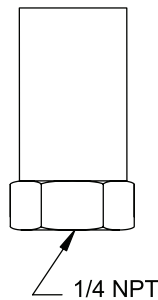

RECOMMENDED PRACTICES AND WARNINGS

United Electric Controls Company recommends careful consideration of the following factors when specifying and installing UE pressure and temperature units. Before installing a unit, the Installation and Maintenance instructions provided with unit must be read and understood.

- To avoid damaging unit, proof pressure and maximum temperature limits stated in literature and on nameplates must never be exceeded, even by surges in the system. Operation of the unit up to maximum pressure or temperature is acceptable on a limited basis (e.g., start-up, testing) but continuous operation must be restricted to the designated adjustable range. Excessive cycling at maximum pressure or temperature limits could reduce sensor life.
- A back-up unit is necessary for applications where damage to a primary unit could endanger life, limb or property. A high or low limit switch is necessary for applications where a dangerous runaway condition could result.
- The adjustable range must be selected so that incorrect, inadvertent or malicious setting at any range point cannot result in an unsafe system condition.
- Install unit where shock, vibration and ambient temperature fluctuations will not damage unit or affect operation. When applicable, orient unit so that moisture does not enter the enclosure via the electrical connection. When appropriate, this entry point should be sealed to prevent moisture entry.
- Unit must not be altered or modified after shipment. Consult UE if modification is necessary.
- Monitor operation to observe warning signs of possible damage to unit, such as drift in set point or faulty display. Check unit immediately.
- Preventative maintenance and periodic testing is necessary for critical applications where damage could endanger property or personnel.
- Electrical ratings stated in literature and on nameplate must not be exceeded. Overload on a switch can cause damage, even on the first cycle. Wire unit according to local and national electrical codes, using wire size recommended in installation sheet.
- Do not mount unit in ambient temp. exceeding published limits.

LIMITED WARRANTY

Seller warrants that the product hereby purchased is, upon delivery, free from defects in material and workmanship and that any such product which is found to be defective in such workmanship or material will be repaired or replaced by Seller (Ex-works, Factory, Watertown, Massachusetts. INCOTERMS); provided, however, that this warranty applies only to equipment found to be so defective within a period of 24 months from the date of manufacture by the Seller. Seller shall not be obligated under this warranty for alleged defects which examination discloses are due to tampering, misuse, neglect, improper storage, and in any case where products are disassembled by anyone other than authorized Seller's representatives. EXCEPT FOR THE LIMITED WARRANTY OF REPAIR AND REPLACEMENT STATED ABOVE, SELLER DISCLAIMS ALL WARRANTIES WHATSOEVER WITH RESPECT TO THE PRODUCT, INCLUDING ALL IMPLIED WARRANTIES OF MERCHANTABILITY OR FITNESS FOR ANY PARTICULAR PURPOSE.

LIMITATION OF SELLER'S LIABILITY

SELLER'S LIABILITY TO BUYER FOR ANY LOSS OR CLAIM, INCLUDING LIABILITY INCURRED IN CONNECTION WITH (I) BREACH OF ANY WARRANTY WHATSOEVER, EXPRESSED OR IMPLIED, (II) A BREACH OF CONTRACT, (III) A NEGLIGENT ACT OR ACTS (OR NEGLIGENT FAILURE TO ACT) COMMITTED BY SELLER, OR (IV) AN ACT FOR WHICH STRICT LIABILITY WILL BE INPUTTED TO SELLER, IS LIMITED TO THE "LIMITED WARRANTY" OF REPAIR AND/OR REPLACEMENT AS SO STATED IN OUR WARRANTY OF PRODUCT. IN NO EVENT SHALL THE SELLER BE LIABLE FOR ANY SPECIAL, INDIRECT, CONSEQUENTIAL OR OTHER DAMAGES OF A LIKE GENERAL NATURE, INCLUDING, WITHOUT LIMITATION, LOSS OF PROFITS OR PRODUCTION, OR LOSS OR EXPENSES OF ANY NATURE INCURRED BY THE BUYER OR ANY THIRD PARTY.

UE specifications subject to change without notice.

FOR A LIST OF OUR INTERNATIONAL AND DOMESTIC
REGIONAL SALES OFFICES PLEASE VISIT OUR
WEBPAGE WWW.UEONLINE.COM



**UNITED ELECTRIC
CONTROLS**

180 Dexter Avenue, P.O. Box 9143
Watertown, MA 02471-9143 USA
Telephone: 617 926-1000 Fax: 617 926-2568
<http://www.ueonline.com>

CP03121500