

Micro Motion® Model 2200S 2-Wire Transmitter with MVD™ Technology

The Micro Motion® Model 2200S 2-wire transmitter enables the use of reliable and accurate Micro Motion Coriolis meters virtually anywhere in your plant. The 2-wire Coriolis meter delivers measurement accuracy, repeatability, and operational savings on a level not previously possible in loop-powered applications.

- Replace existing 2-wire flow devices with minimal effort and without incurring additional power or cabling costs
- Wireless THUM™ option maximizes installation and operation flexibility
- Low energy, loop-powered design enables easy integration of Coriolis into existing processes for improved measurement and reduced maintenance for an even greater number of flow points
- Reduce the complexity and improve the performance of new process plants with loop-powered mA output and HART protocol 2-wire Coriolis
- Compact, integral 2-wire transmitter design saves electrical cost and space for use on integrated systems and skids
- Direct mass measurement improves process control while reducing number of measurement devices required
- Accurate, repeatable measurement ensures higher quality production and overall improved process profitability

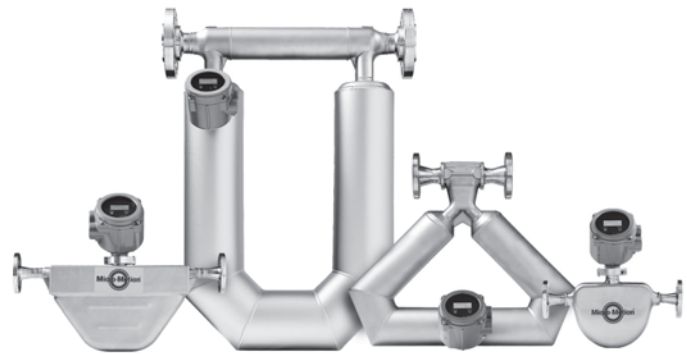

2200S	2400S	1700 2700	1500 2500	3300 3350	3500 3700	5700
Compact integral 2-wire transmitter	Compact integral transmitter	Versatile field-mount transmitter	Compact control-room transmitter	Frequency-input discrete controller	Integrated control and measurement platform	Advanced field-mount transmitter



Micro Motion® 2-Wire Coriolis flow and density meter

Utilizing Micro Motion MVD technology, the Micro Motion 2-wire Coriolis meter delivers multivariable and diagnostic information via HART® communications. Comprised of a cutting-edge Model 2200S transmitter and the proven best-in-class performance of a Micro Motion Coriolis meter, the Micro Motion 2-wire meter brings reduced costs through improved process consistency and maximized uptime. Micro Motion 2-wire Coriolis is ideally suited for use in the chemical, petrochemical and refining industries, and for continuous process and mass balance applications.

MVD technology

MVD technology makes your Micro Motion flowmeter work smarter. Front-end digital processing dramatically reduces signal noise and gives you faster response time compared to analog devices.

Only MVD technology allows you to:

- Measure multiple variables for accurate process control
- Identify and resolve problems easily with built-in smart diagnostics
- Flexible architecture enables tuning for your application needs
- Upgrade transmitter functionality as needed, without impacting availability

Model 2200S transmitters

The Model 2200S transmitter is suitable for a range of process conditions, including CSA Class I Div. 1 and ATEX Zone 1 approvals. To facilitate installation in hazardous areas, Micro Motion offers an adapter-barrier. Finally, the Micro Motion Model 2200S is also available with a 316L stainless steel enclosure suited for harsh environments, such as applications in the offshore and marine industries.

Table of Contents

Applications	3	Environmental effects	6
Input/output signal detail	4	Hazardous area classifications	6
Electrical connections	4	Physical specifications	7
Power supply	5	Dimensions	8
Environmental limits	5	Ordering Information	10

Applications

The Micro Motion adapter-barrier provides Class I, Div. 1 and Zone 1 intrinsic safety protection, and re-spans the I/O signal from 12–20 mA to 4–20 mA.

Transmitter to host with no barrier

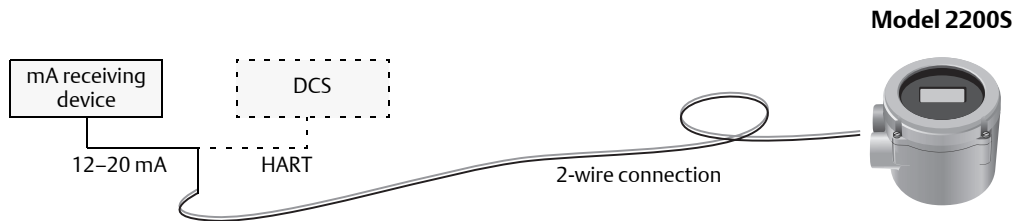

Transmitter to host with third-party barrier

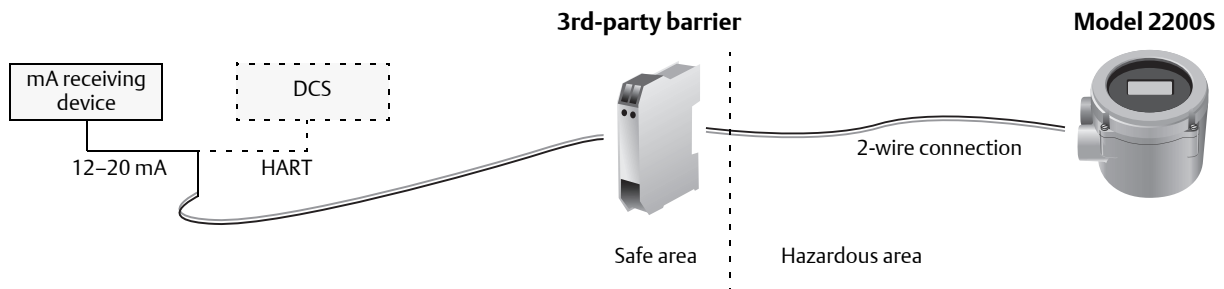

Transmitter to host with Micro Motion adapter-barrier

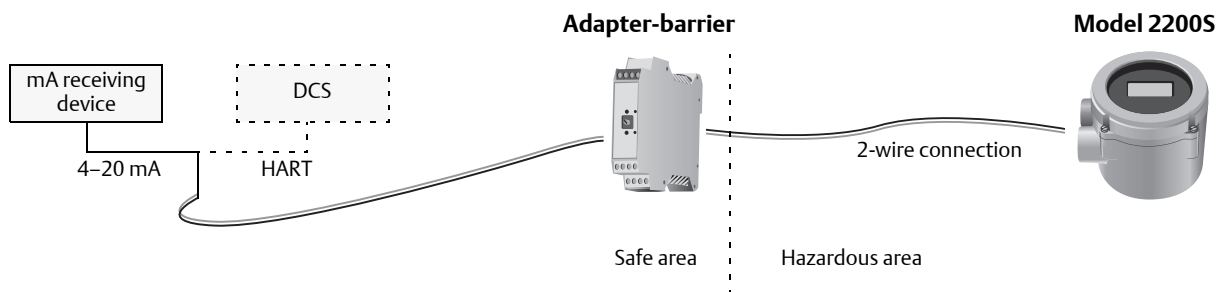

Electrical connections

Connection type	Transmitter	Adapter-barrier
Input/Output	<ul style="list-style-type: none"> ■ One pair of wiring terminals for transmitter input/output, digital communications, and power. ■ Screw terminals accept solid or stranded conductors, 26 to 14 AWG (0.14 to 2.5 mm²). 	Wire gauge: 0.2 mm ² (24 AWG) minimum, 2.5 mm ² (14 AWG) maximum
Digital communications administrative connection	<ul style="list-style-type: none"> ■ Two clips on the display for a temporary connection to HART/Bell 202 terminals. ■ Loop resistance is required on main terminals. Loop resistance must be present in the main I/O loop, but not physically on the main terminal block. ■ No resistor is allowed on temporary connections. 	

Input/output signal detail

Transmitter code	Descriptions
Channel A	One passive 12–20 mA output <ul style="list-style-type: none"> ■ Isolated to ±50 VDC from earth ground ■ Maximum load limit: 600 Ω ■ External power: 17 to 36 VDC ■ Can report mass flow, volume flow, gas standard volume flow or density ■ Output is linear with process from 11.9 to 20.25 mA ■ Intrinsically safe (purchase option)
Adapter-barrier code	Descriptions
Field side: terminals 1 and 2	One active 12–20 mA input <ul style="list-style-type: none"> ■ Over/under range: 11–21 mA ■ HART pass-through ■ Loop supply: > 25 V ■ HART-compliant impedance: > 250 Ω ■ Intrinsically safe (purchase option)
Host side: terminals 23 and 24	One active or passive 4–20 mA output <ul style="list-style-type: none"> ■ Under/over range: 2–22 mA ■ Maximum load limit (active output): < 1 kΩ ■ Maximum loop voltage (passive input): < 36 V ■ Trimmable endpoints (0% and 100%) ■ Linearity: < 0.05% span ■ Conforms to NAMUR NE43 (February 2003) (depending on transmitter configuration)

Digital communications

Transmitter output type	Descriptions
HART Bell 202 ⁽¹⁾	<p>HART signal is superimposed on the milliamp output, and is available for host system interface:</p> <ul style="list-style-type: none"> ■ Frequency: 1.2 and 2.2 kHz ■ Amplitude: to 1.0 mA ■ 1200 baud, one stop bit, odd parity ■ Address: 0 (default), configurable ■ Requires 250 to 600 W resistance

(1) RS-485 connections are not supported.

Power supply

Type	Description	
Transmitter (DC)	<ul style="list-style-type: none"> ■ External power: 17–36 VDC ■ Loop resistance up to 600 Ω ■ 0.8 W maximum 	
Adapter-barrier	Isolation voltage	<ul style="list-style-type: none"> ■ Power to field side: > 1500 VAC ■ Power to host side: > 500 VAC ■ Field to host side: > 1500 VAC
	Terminals 11 and 12	<ul style="list-style-type: none"> ■ 18–42 VDC ■ Maximum supply current: 170 mA ■ Maximum power: 3 W

Environmental limits

Environmental factor		°F	°C
Ambient temperature limits	Operating	-40 to +140	-40 to +60
	Storage	-40 to +158	-40 to +70
Humidity limits	5 to 95% relative humidity, non-condensing at 140 °F (60 °C)		
Vibration limits	Meets IEC 60068-2-6, endurance sweep, 5 to 2000 Hz, 50 sweep cycles at 1.0 g		
Housing rating	Transmitter	NEMA 4X (IP66/67) polyurethane-painted cast aluminum or 316L stainless steel	
	Adapter-barrier	IP20	

Environmental effects

EMI effects

- Complies with EMC directive 2004/108/EC per EN 61326 Industrial
- Conforms to NAMUR NE21 Version: 08.22.2007

Ambient temperature effect

On mA output: ±0.005% of span per °C









Hazardous area classifications

Model 2200S transmitter

CSA C-US

- Ambient temperature -40 to +140 °F (-40 to +60 °C)
- Class I, Div. 1, Groups C and D
- Class I, Div. 2, Groups A, B, C, and D
- Class II, Div. 1, Groups E, F, and G

ATEX

Electronic option code H or K	 0575  II 2G Ex ib IIB/IIC T4 II 2D Ex ibD 21 T70 °C
	  II 3G Ex nA II T4 II 3D Ex tD A22 IP66/67 T70 °C
Electronic option code 5 or 6 (THUM adapter)	 0575  II 2G Ex ib IIB/IIC T4
	  II 3G Ex nA IIC T4

IECEX

- Ex ib IIB/IIC T4
- Ex nA II T4

Adapter-barrier

CSA C-US

- Class I, Div. 1, Groups C and D⁽¹⁾
- Class I, Div. 2, Groups A, B, C, and D
- Class II, Div. 2, Groups F and G

(1) When installed in a suitable enclosure.

ATEX

CE 0575 $\langle \text{Ex} \rangle$ II (2) G [Ex ib] IIB/IIC
II (2) D [Ex ibD]

IECEX

[Ex ib] IIB/IIC

Physical specifications

Transmitter

Specification	Value
Housing	NEMA 4X (IP66/67) polyurethane-painted cast aluminum or 316L stainless steel. Available with 1/2" NPT or M20 conduit connections
Weight	See the sensor Product Data Sheet for combined weight of the flowmeter
Cable gland entrances	One 1/2"–NPT or M20 x1.5 female conduit port for output and power supply
Mounting	<ul style="list-style-type: none"> ■ Integral-mount or extended-mount ■ Available integrally mounted to Micro Motion ELITE and F-Series sensors ■ The transmitter can be rotated on the mounting in 45° increments, for eight different orientations.
Interface/display	<p>Standard user interface with LCD panel</p> <ul style="list-style-type: none"> ■ Suitable for hazardous area installation. ■ User interface module can rotate 360° on the transmitter in 90° increments. ■ Two clips for HART/Bell 202 connections (requires removing transmitter housing cover). ■ Two membrane pushbuttons for local operation (requires removing transmitter housing cover). ■ Depending on purchase option, transmitter housing cover has glass or plastic lens. ■ User interface module includes LCD panel. LCD line 1 displays process variable; line 2 displays engineering unit of measure, with optional alarm indication. ■ LCD panel can be configured to scroll through display list at user-specified scroll rate. Display list includes user-selected process variables and, optionally, all active alarms. ■ Display update rate is user-configurable: 100 to 10,000 milliseconds.

Adapter-barrier

Specification	Value
Housing	IP20
Weight	0.33 lb (0.15 kg)
Mounting	<ul style="list-style-type: none"> ■ DIN rail mounting type: DIN 46277 ■ Can be stacked side-to-side

Dimensions

Transmitter

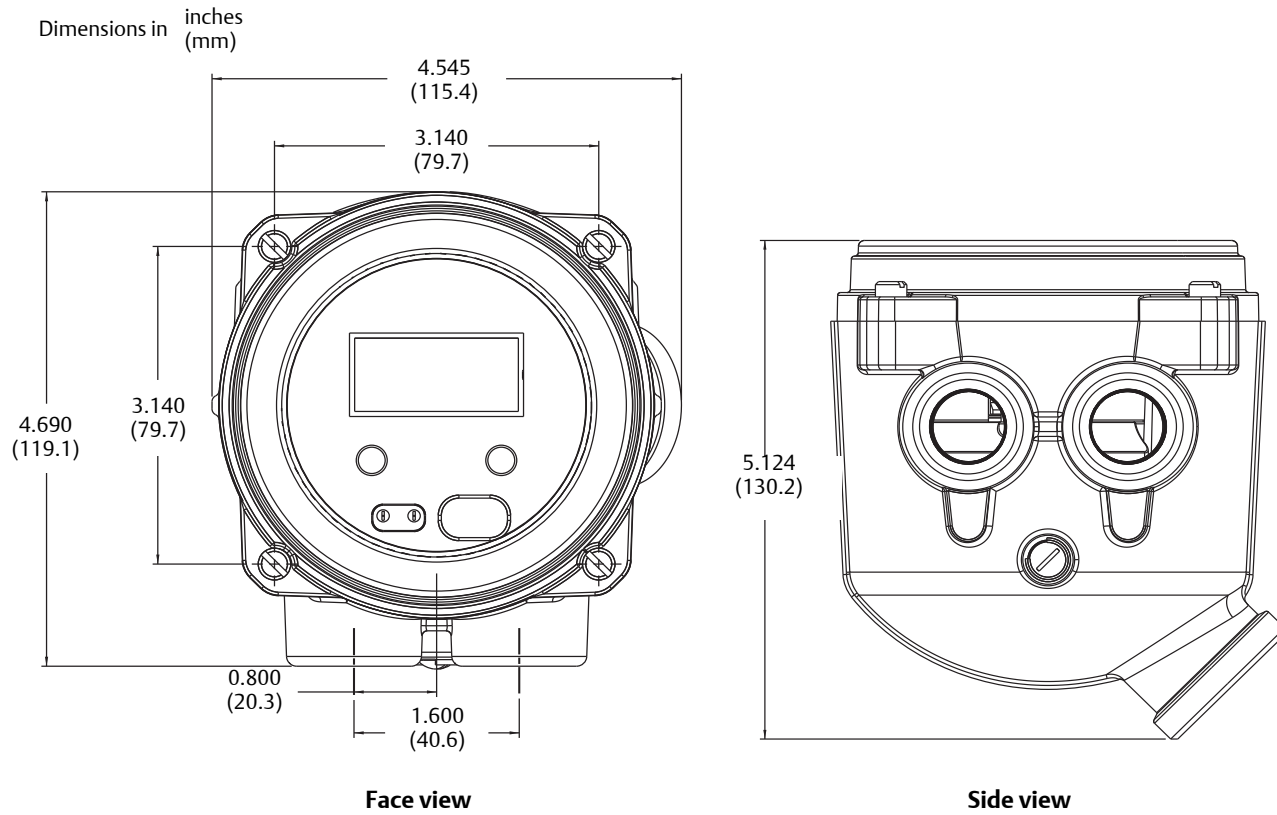

Adapter-barrier

Dimensions in inches
(mm)

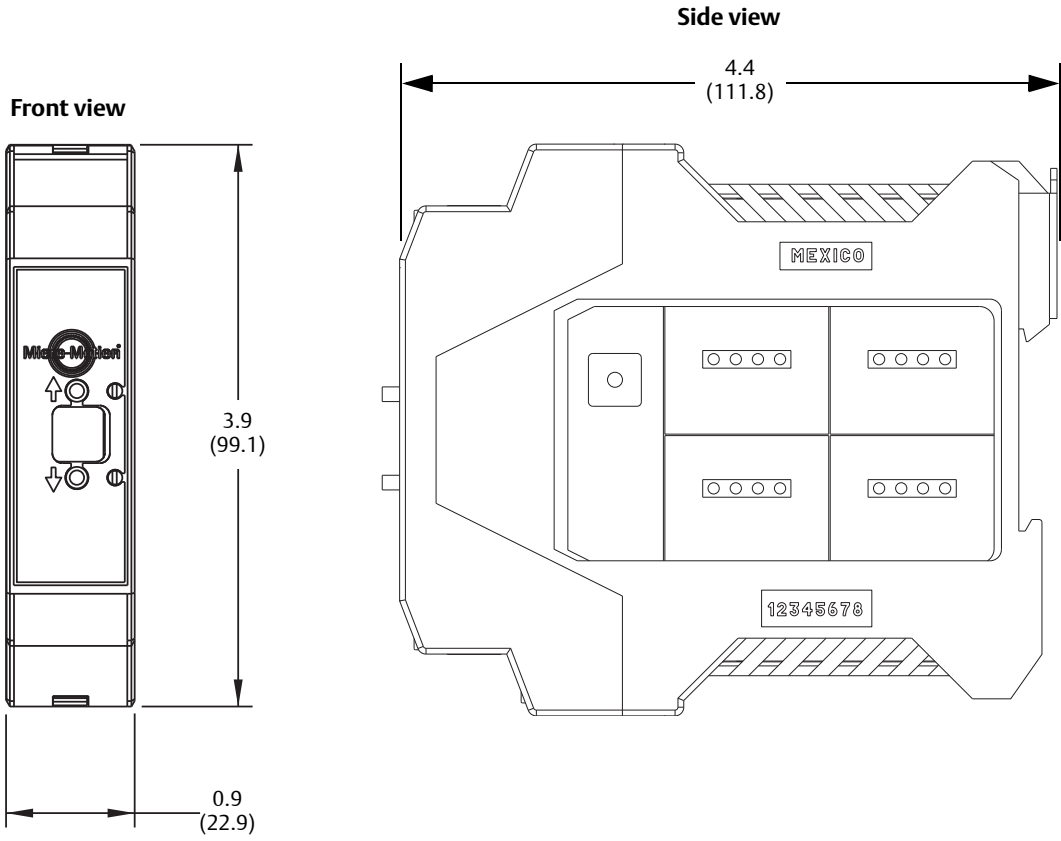

Ordering Information

Product code structure for Model 2200S

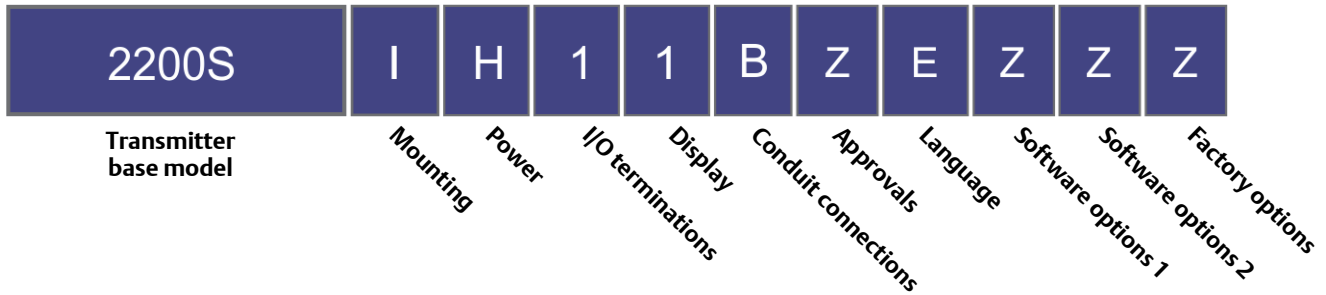

Base model

Model	Product description
2200S	Micro Motion Coriolis 2-wire MVD transmitter. Must be ordered with a sensor.

Mounting

Code	Mounting options
I	Integral mount transmitter, polyurethane-painted aluminum
J ⁽¹⁾	Integral mount transmitter, 316L stainless steel

(1) Not recommended for truck-mount

Power

Code	Output options / power supply
H ^{(1) (2)}	One 12–20 mA output with HART (loop power)
5	One 12–20 mA output with HART (loop power), wireless HART (775 integrally mounted, order separately)
K	One 4–20 mA output with HART (loop power), supplied with a Micro Motion adapter-barrier
6 ^{(1) (3)}	One 4–20 mA output with HART (loop power), supplied with Micro Motion adapter-barrier, wireless HART (775 integrally mounted, order separately)

(1) Not recommended for truck-mount

(2) Display code 4 available with approval code M

(3) Not available with approval codes T, S, or J

I/O terminations

Code	I/O termination option
1	Compression screw terminals

Display

Code	Transmitter display options
1	Dual-line display for process variables and totalizer reset
4 ⁽¹⁾	Non-glass dual-line display for process variables and totalizer reset

(1) Available with only approval code M.

Conduit connections

Code	Conduit connection options
B	1/2-inch NPT – no gland
C	1/2-inch NPT with brass/nickel cable gland
D	1/2-inch NPT with stainless steel cable gland
E	M20 – no gland
F	M20 with brass/nickel cable gland
G	M20 with stainless steel cable gland

Approvals

Code	Terminal options
M	Micro Motion standard (no approval with CE/EAC markings)
L	ATEX – Equipment Category 3 (Zone 2)
3	IECEX Zone 2
A	CSA (U.S.A. and Canada)
Z	ATEX – Equipment Category 2 (Zone 1)
I	IECEX Zone 1
J ⁽¹⁾	TIIS – Hardware ready
T	TIIS – IIC sensor
S	TIIS – IIB sensor
G	County-specific approval – Requires a selection in the Add-on options table

(1) Available with only T and S approval codes

Language

Code	Display and documentation language
E	English installation manual and English configuration manual
F ⁽¹⁾	French installation manual and French configuration manual
G ⁽¹⁾	German installation manual and German configuration manual
J	Japanese installation manual and Japanese configuration manual
M ⁽¹⁾	Chinese installation manual and Chinese configuration manual
S ⁽¹⁾	Spanish installation manual and Spanish configuration manual

(1) Not available with approval codes T, S, or J

Software options 1

Code	Software options 1
Z	No software options 1

Software options 2

Code	Software options 2
Z	No software options 1

Factory options

Code	Factory applications
Z	Standard product
X	ETO product

Add-on options

Code	Add-on options (optional)
For output and power option 5 or 6 only	
PI	Model 775 integrally mounted at the factory, wiring completed in the field
NI	Model 775 not installed, installation and wiring completed in the field
County-specific approvals. Must select only one when approval option G is selected.	
R1 ⁽¹⁾	EAC Zone 1 – Hazardous area approval
R3 ⁽¹⁾	EAC Zone 2 – Hazardous area approval
B1 ⁽¹⁾	INMETRO Zone 1 – Hazardous area approval
B3 ⁽¹⁾	INMETRO Zone 2 – Hazardous area approval

(1) Available with only approval G.

Emerson Process Management Americas

7070 Winchester Circle
Boulder, Colorado USA 80301
www.MicroMotion.com
www.Rosemount.com
T: +1 800 522 6277
T: +1 (303) 527 5200
F: +1 (303) 530 8459

Mexico T: 52 55 5809 5300
Argentina T: 54 11 4837 7000
Brazil T: 55 15 3413 8000
Venezuela T: 58 26 1300 8100
Chile T: 56 2 2928 4800

Emerson Process Management Europe/Middle East

Central & Eastern Europe T: +41 41 7686 111
Dubai T: +971 4 811 8100
Abu Dhabi T: +971 2 697 2000
France T: 0800 917 901
Germany T: 0800 182 5347
Italy T: 8008 77334
The Netherlands T: +31 (0) 70 413 6666
Belgium T: +32 2 716 77 11
Spain T: +34 913 586 000
U.K. T: 0870 240 1978
Russia/CIS T: +7 495 981 9811

Emerson Process Management Asia Pacific

Australia T: (61) 3 9721 0200
China T: (86) 21 2892 9000
India T: (91) 22 6662 0566
Japan T: (81) 3 5769 6803
South Korea T: (82) 2 3438 4600
Singapore T: (65) 6 777 8211

© 2015 Micro Motion, Inc. All rights reserved.

The Emerson logo is a trademark and service mark of Emerson Electric Co. Micro Motion, ELITE, ProLink, MVD and MVD Direct Connect marks are marks of one of the Emerson Process Management family of companies. All other marks are property of their respective owners.

Micro Motion supplies this publication for informational purposes only. While every effort has been made to ensure accuracy, this publication is not intended to make performance claims or process recommendations. Micro Motion does not warrant, guarantee, or assume any legal liability for the accuracy, completeness, timeliness, reliability, or usefulness of any information, product, or process described herein. We reserve the right to modify or improve the designs or specifications of our products at any time without notice. For actual product information and recommendations, please contact your local Micro Motion representative.

